

铝合金平行-推拉-上悬门

Parallel sliding and turn for doors hardware



配置方案

A型
DIN左

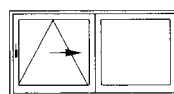

或者
DIN右

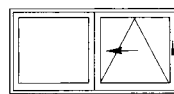

G型
DIN左

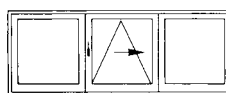

或者
DIN右

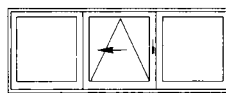

C型

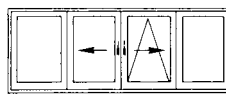

K型

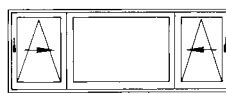

PSK 和 PSK-Z 推拉 - 上悬门系列五金件:

- 有效节省了开启时占用的空间
- 能实现平开门同等的密封效果
- 提供了最大 200kg 的承重要求(PSK-Z)
- 让冬季房间的通风更加的科学
- 只需操作执手便轻松实现开闭(PSK-Z)



- Efficiently save the space needed for opening
- Reach the same sealing effect as that of the side-hung door
- Provide the bearing requirement of 200KG at the maximum
- Make the ventilation of the winter room more scientific
- Easily open and close the sash only with the help of the operating handle

PSK-PORTAL LM 铝合金平行-推拉-上悬门五金件

Parallel-tilt-slide for aluminum doors

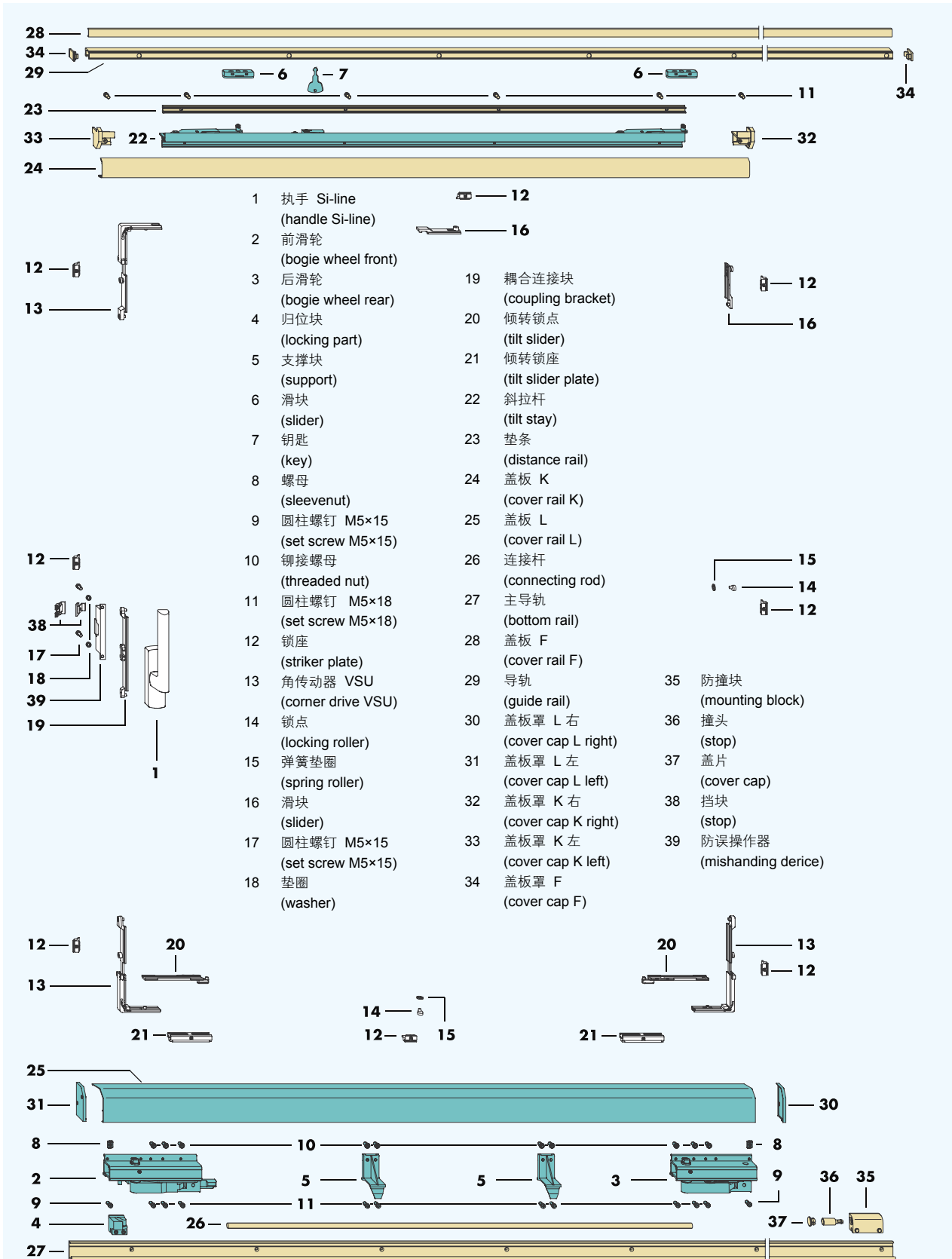

PSK-PORTAL LM 铝合金平行-推拉-上悬门五金件

Parallel-tilt-slide for aluminum doors

		门(door)	
扇宽(sash width) (mm)	700-1650	最大(Max.)3460 (外框out frame)	
扇高(sash height) (mm)	850-2400	—— (外框out frame)	
扇重(sash weight) (kg)	标配(standard)150	最大(Max.)200	
扇框复合处厚度(over rebate thickness)(mm)	7到10		
防腐试验标准(corrosion test standard)	DIN 50021 SS		
气密性试验标准(gap test standard)	DIN EN 12207		
水密性试验标准(water tightness standard)	DIN EN 12208		
防盗等级(security class)	标准型(standard model)		

	图号 (drawing number)	名称 (number)	标号 (standard number)	数量(件、套)/方案				适用标准 suitable standard		备注 (remarks)
			(黑棕色)	A	G	C	K	扇宽(mm) sash width	框宽(mm) frame width	
常用部件 (often used parts)	1	执手 Si-line PSK LM(handle)	262306	1	1	2	2	--	--	颜色可选 (color selectable)
	2-11	PSK-PORTAL LM 产品组合(滑轮) 右(right) 左(left)	120064	1	1	1	1	--	--	
			120071	1	1	1	1	--	--	
	12-21	PSK-PORTAL LM 产品组合(锁紧侧)	218310	1	1	2	2	--	--	
	22-37	PSK-PORTAL LM 产品组合(适配)	119792	1	1	2	2	700-900	--2000	颜色可选 (color selectable)
			119822	1	1	2	2	901-1100	2001-2400	
			119853	1	1	2	2	1101-1300	2401-2860	
			119884	1	1	2	2	1331-1650	2861-3460	
	38-39	PSK-PORTAL 防误操作器组合 (mishandling device)	818824	1	1	1	1	--	--	
			819739	1	1	1	1	--	--	

此表仅供参考，不作正式配置使用(Only used conference)

